

Sinergi Yeni

by Andi Adriansyah

Submission date: 14-Mar-2019 03:17PM (UTC+0700)

Submission ID: 1093140105

File name: 01_Azriyeni_-_Photovoltaic_Modeling.pdf (306.96K)

Word count: 2925

Character count: 14339

PHOTOVOLTAIC MODELING METHODS BASED ON MATLAB SIMULINK IMPLEMENTATION

Azriyenni Azhari Zakri, Nurhalim, Dohardo P.H, Simanulang, Ihwalibi Tribowo
Study Program of ²⁰Electrical Engineering, Faculty of Engineering, University of Riau, Pekanbaru
Campus of Bina Widya, Simpang Bani, Tampan, Pekanbaru, Riau 28293 Indonesia
Email: azriyenni@eng.unri.ac.id

Abstract – This paper presents photovoltaic system as a stand-alone electric power plant in the renewable energy development. To maximize these stand-alone generators, it is necessary to design photovoltaic modeling to produce energy and maximum power. The problems that exist in the design of PV systems are PV configuration, battery size, and the maximum power system. Therefore, this research will be proposed modeling Matlab/Simulink based PV system. The contribution of this research can provide various characteristics of the photovoltaic system with a capacity of 100 Wp. This modeling is designed using Matlab/Simulink software. The data generated from this simulation will provide a good reference for designing the stand-alone generators in the future.

Keywords: Renewable energy; Photovoltaic; Electric System; Temperature System

INTRODUCTION

Electrical technology for the Renewable Energy (RE) uses solar energy source as an alternative source of reliable energy. Some of the problems arising in the photovoltaic system (PV) among others: prediction of PV configuration and battery size, energy consumption prediction, maximum power system and performance analysis of PV system. The PV system modeling is an initial phase to be considered, such as size, identification ¹¹ simulation applications. In some literature, models have been proposed for modeling of different components on the stand-alone PV. Some methods are based on ¹¹ software simulation namely by using the program such as, PSpice, Matlab Simulink and Labview (Wahid and Hambal, 2015; Rameriah et al., 2014; Mizuki et al., 2014).

This article will introduce a model of solar radiation based on weather forecasting system. It produces ¹⁸ short term photovoltaic output predictions from the forecasting information from the meteorological department. Based on the output results of solar radiation and distribution network, then an algorithm can be generated. The prediction model of produced photovoltaic power can predict the output and algorithm in computational speed (Bastidas-Rodriguez et al., 2018; Mai et al., 2017; Lin, 2012).

Meng et al. (2014) have proposed to utilize solar power plant (photovoltaic) on a ¹³ micro grid system with DC voltage source. The battery charging and discharging system is connected to ¹³ traction system through a DC bus. For tracking the maximum power point is adopted on the solar power plant. Consequently, if applied for locomotives on working condition and regenerative braking produce a more stable voltage.

Akos Baldauf (2015) has developed an RE

source for housing by using the photovoltaic system as a smart home design (Adriansyah and Dani, 2014). For controlling the production of electrical power to the grid system is using Demand Side Management (DSM) technique. This technique is applied for the purpose to reduce ²⁷ lower costs as well as power losses on the grid. A scheduling algorithm is applied by using consumer historical data.

Darbali-Zamora and Ortiz-Rivera (2016) have also developed a new alternative energy that is environmentally friendly as a source of solar panel power plant. This solar panel needs a power ³ management approach that is able to extract maximum power. The Maximum Power Point Tracking (MPPT) is a technique used to gain maximum power from one or more solar panels. This technique allows the sun to operate on voltage ³ and current at the optimum value. MPPT algorithm is used in combination with DC voltage to ³ This converter is able to convert DC voltage into different regulated DC voltage. The optimum ratio of the converter allows the solar panels to operate ²² optimally.

The main objective of this research is to design the modeling and simulation of PV system as the power supply. This PV system model will be operated on the condition of solar radiation and PV temperature variable. This is to analyze the effect of solar absorption process and charging to the battery. This modeling and simulation will be implemented by using Matlab/Simulink.

LITERATURE REVIEW

Solar energy in the form of electromagnetic radiation that is emitted to the earth in the form of sunlight consisting of photons or solar energy particles, which are converted into electrical

energy. The solar energy getting at the surface of the earth is called a global solar radiation that is measured by power density at the surface of the receiving area. The average value of the earth's atmospheric solar radiation is 1,353 W/m² stated as a solar constant.

The solar radiation intensity is affected by the cycle time of the earth's rotation. Weather condition comprises cloud quality and quantity, the season change and latitude position. The solar radiation intensity in Indonesia runs for 4 - 5 hours per day (Tsuiji and Matsumoto, 2014).

Photovoltaic (PV)

The PV technology is designed to capture solar energy in order to produce higher PV output voltage comparing to battery voltage. The PV output voltage can be adjusted by using a Solar Charge Controller (SCC) that is functioning as a voltage regulator to the battery. The initial design that can be done for the distribution of electrical energy is to determine the amount of energy required. In this research will be simulated solar cell based on the Matlab/Simulink with Solar 100 Wp (Watt-Peak) capacity. At that capacity will be observed the influence of solar radiation, temperature, PV voltage, PV current and battery charging process. In order to keep the battery security, then it is necessary to observe the voltage when charging the battery. SCC will operate on DC voltage and can stabilize the voltage released from the PV at the time of charging the battery.

Battery

The battery is storing the appropriate electrical energy used for PV. If the battery capacity is 100 Ah with a voltage of 12 V_{dc}, the battery efficiency is about 80%. The battery charging time is for 12 - 16 hours. The energy unit (Watt-hour) is converted to Ah so that the battery capacity can be calculated by using Formula (1).

$$Ah = Wh / V_s \quad (1)$$

The unit of the day to store and distribute energy to the load is determined one day, so the battery only stores the energy and distributes it on the same day. The rate of Deep of Discharge (DOD) on the battery is 80%. The calculation of required battery capacity is shown in Formula (2).

$$C_b = \frac{AH \times d}{DOD} \quad (2)$$

Inverter

An inverter is an electrical device having the ability to convert DC voltage into AC voltage with an adjustable frequency value. An ideal inverter is when the incoming DC voltage is free of ripple and the voltage coming out of the inverter is a pure sinusoidal wave (AC).

Most of the inverters used are Pulse Width Modulation (PWM) Inverters, using the concept of PWM switching. PWM Inverter is a process of changing the wave signal with the principle of setting the size of the wave pulse width. PWM technique is likened to a manipulation technique in processing wave signal by using switching principle. Therefore, the setting of the wave signal is on and off. One phase PWM inverters can be realized with bipolar switching and unipolar switching. Bipolar switching is a switching condition that experiences a condition of positive and negative voltage pulses. While the unipolar switching can be defined as the condition of the switching, which has a positive, negative, and zero voltage condition.

METHOD

This research is carried out by designing photovoltaic modeling as electric power plant by using Matlab/Simulink. Fig. 1 shows the solar cell absorption process in the photovoltaic system part modeling by Matlab/Simulink. A capacity of simulated PV can be selected (in this model 100 Wp). In Fig. 1, it has also been simulated to show the value of solar radiation and PV temperature to see the prediction of PV output voltage and battery charging process.

Fig. 2 is a battery charging process model based on Matlab/Simulink. In this Fig. 2 will show the simulation at some of solar radiation and PV temperature. The voltage and current output of the PV at a capacity of 100 Wp affect the battery charging process. This modeling is simulated comprehensively with solar radiation variations of 100 W/m² up to 1000 W/m².

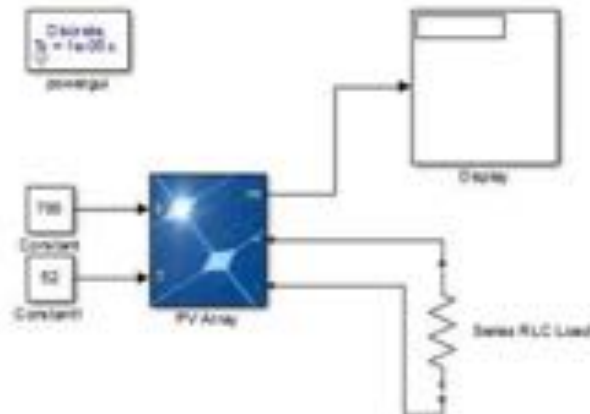

Figure 1. Photovoltaic Modeling

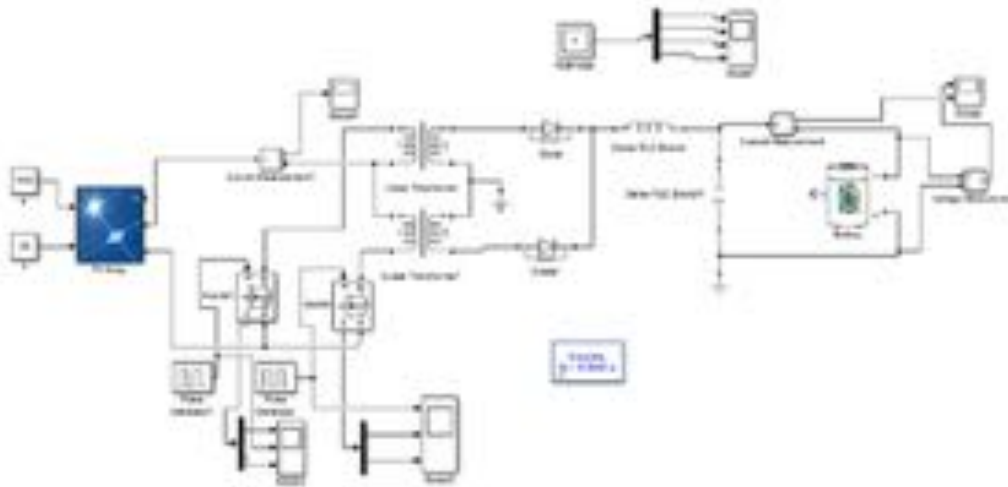

Figure 2. Battery charging modeling

This research applies the simulation by using Simulink methods. Then the simulation is to generate data that can be a reference to the design of a stand-alone PV power plant. The following section will present the results and analysis of this study.

RESULT AND DISCUSSION

The result of simulation from photovoltaic system modeling by using Matlab/Simulink methods is shown in Table 1. The condition of State of Charge (SOC) at the time of solar absorption is in the range of 12% up to 84%. Analysis of the simulation result of this photovoltaic generator modeling is presented in Fig. 3 – Fig. 7.

Fig. 3 shows the simulation result on the absorption of solar radiation (I_t) condition to the PV panel with a range of solar radiation from 100 W/m^2 up to 1000 W/m^2 . The measured temperature in the PV panel is obtained from 32°C up to 52°C. Then, the voltage of PV (V_{PV}) is obtained at amount 18 V_{DC} up to 21 V_{DC} . It shows that the voltage produced by the PV is higher than the battery voltage (12 V_{DC}).

Fig. 4 shows the simulation result of the photovoltaic current (I_{PV}) condition is at the range of 0.9 A up to 5.3 A. Such condition is read when the photovoltaic temperature (T_{PV}) starts from 32°C up to 52°C.

Table 1. Simulation Result of Photovoltaic System

I_s (W/m ²)	T_{ref} (°C)	T (°C)	V_{oc} (V)	I_{sc} (A)	V_b (V)	I_b (A)	SOC (%)
500	32	31.4	21.9	0.9	12.41	5.0	18
700	35	32.3	21.2	1.5	12.48	5.2	19
200	36	32.8	20.0	2.4	12.77	2.2	12
300	42	32.9	19.9	2.7	12.64	5.2	28
900	35	33.0	21.6	1.9	12.60	5.0	21
500	45	33.4	20.2	5.0	13.04	1.0	31
1000	44	33.9	21.0	4.2	13.08	5.2	38
100	46	34.2	18.3	5.3	13.21	0.7	44
400	48	35.1	19.7	4.6	12.39	0.8	13
600	42	35.2	20.6	4.5	13.31	5.7	53
800	45	35.8	20.6	4.2	13.47	5.1	63
700	47	36.0	20.3	4.6	13.22	3.6	35
300	44	36.2	19.7	4.7	13.42	5.2	55
100	47	36.6	18.3	4.9	13.66	0.9	68
600	47	37.0	20.2	3.8	13.50	0.5	49
400	50	37.2	19.5	5.0	13.81	0.5	72
600	46	37.5	20.3	4.9	14.27	3.7	59
400	47	37.6	19.8	0.8	12.89	2.2	52
500	52	37.7	19.6	4.8	14.00	5.0	77
700	52	38.0	19.9	4.6	13.96	2.8	55
400	49	38.3	19.6	4.9	13.01	5.0	84

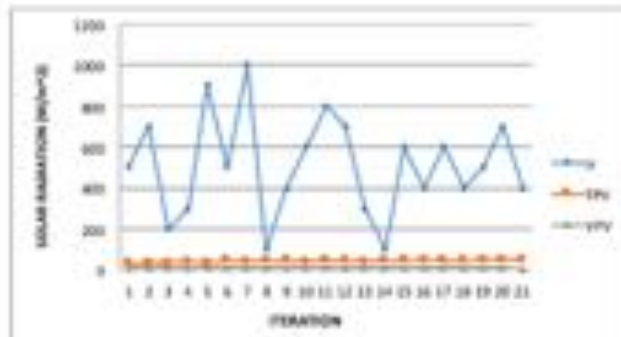

Figure 3. Graphic of solar radiation absorption

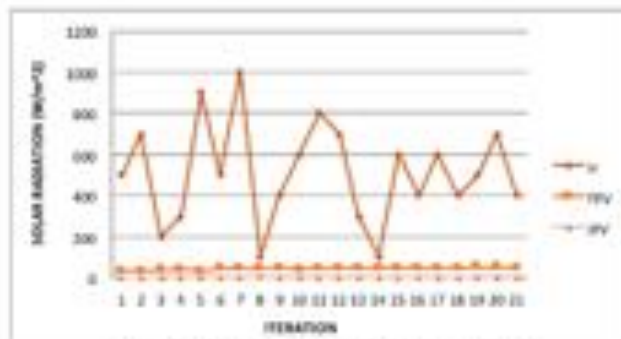

Figure 4. Graphic of PV Current to Regulator

Fig. 5 shows the simulation result of battery charging condition with battery voltage (V_b) in the range of 12.4 V_{oc} up to 14 V_{oc} . While the battery current (I_b) is at the range of 0.5 A up to 5.7 A. The incoming voltage to the battery has been stabilized by the regulator, then it is nearly to the nominal value of the battery (12 V_{oc}).

Fig. 6 shows the highest error percentage analysis of 2.4%. It indicates that the condition at the time of battery charging, the product is nearly expected. And then at the time of the battery charging, the SOC position is in the range of 12% up to 84%.

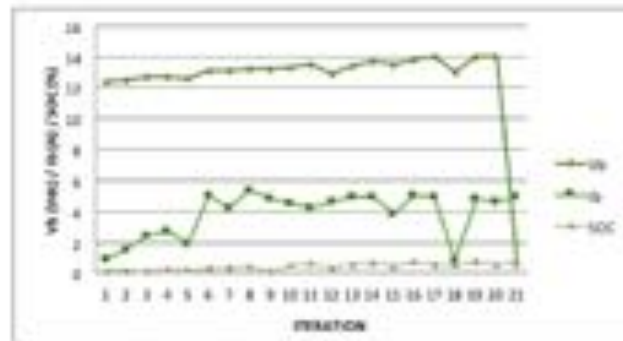

Figure 5. Graphic of battery charging

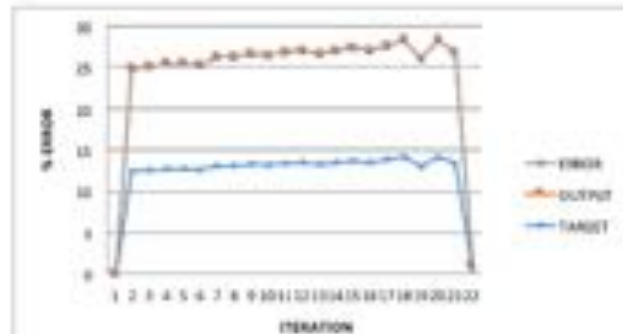

Figure 6. Graphic of Photovoltaic Current Error Percentage to SCC

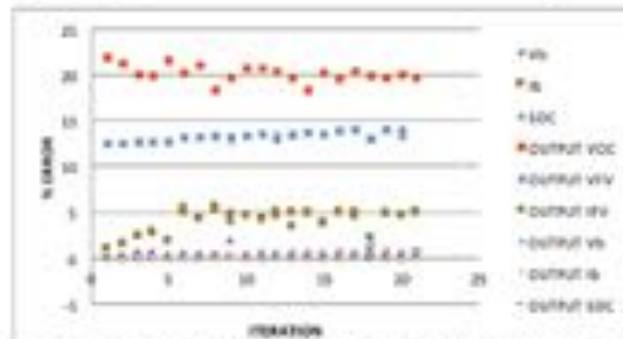

Figure 7. Graphic of Photovoltaic System Error Percentage to Battery

Fig. 7 shows error percentage analysis for the photovoltaic process system to reach the battery. The parameters shown in the graph are V_{pv} , I_{pv} , SOC, V_b , and I_b . For the voltage (V_{pv}), the smallest error percentage rate is 0.0001% and the highest error percentage rate is 2.4%.

This PV modeling has been flexibly designed and simulated with photovoltaic (Wp) capacity as required. Therefore, the simulation result can provide predictions in the design of the prototype. Simulation and analysis result is expected to provide characteristics of PV system

with 100 Wp capacity. Some of the characteristics produced are; characteristics of solar radiation absorption system, PV characteristics toward the regulator and characteristics of battery charging. The photovoltaic system can be a reference for the design of the prototype with the capacity as we desire in the future.

CONCLUSION

The result of this modeling design is a Photovoltaic system with a capacity of 100Wp as an energy source by using Matlab/Simulink

methods. The capacity of this stand-alone generator can be planned in accordance with what we desire, therefore it makes us easy to determine the electricity needs of consumers. Simulation is also carried out to generate prediction data of stand-alone electric power plant. The simulation result and the analysis to result have provided various characteristics of solar radiation absorption system, PV characteristics toward the Regulator and characteristics of battery charging. The photovoltaic system can be a reference for the design of the prototype with the capacity as we desire in the future.

Nomenclature

SOC	= State of Charge
DOD	= Deep of Discharge
CC	= Solar Charge Controller
V_{ac}	= Voltage Alternating Current
V_{dc}	= Voltage Direct Current
Ah	= Ampere Hour
PV	= Photovoltaic
I	= Solar Radiation
T_A	= Photovoltaic Temperature
I_A	= Photovoltaic Current
V_A	= Photovoltaic Voltage
V_b	= Battery Voltage
I_b	= Battery Current
Wh	= Watt per Hour
C_b	= Battery Capacity required

REFERENCE

- Adriansyah, A. and Dani, A.W. (2014). Design of Small Smart Home system based on Arduino. 2014 Electrical Power, Electronics, Communications, Control and Informatics Seminar (EECCIS). 121-125. <http://dx.doi.org/10.1109/EECCIS.2014.7003731>
- Baldauf, A. (2015). A smart home demand-side management system considering solar photovoltaic generation. 2015 5th International Youth Conference on Energy (IYCE) 1-5. <http://dx.doi.org/10.1109/IYCE.2015.7180731>
- Bastidas-Rodriguez, J.D., Trejos-Grisales, L.A., González-Montoya, D., Ramos-Paja, C.A., Petrone, G., and Spagnuolo, G. (2018). General modeling procedure for photovoltaic arrays. *Electric Power Systems Research*, 155, 179. <http://dx.doi.org/10.1016/j.epsr.2017.08.023>
- Dani, R., Zamora, R. and Ortiz-Rivera, E.I. (2016). Optimal Duty Ratio Maximum Power Point Tracking Technique Using the SEPIC Topology for Photovoltaic Systems Applications. 2016 IEEE ANDESCON 1-4. <http://dx.doi.org/10.1109/ANDESCON.2016.7836257>
- Lin, M., Wang, Z., Liu, Y., Chen, M., and Meng, F. (2012). Power Prediction Model of Grid Connected Photovoltaic and Power Flow Analysis. 2012 Asia-Pacific Power and Energy Engineering Conference. 1-4. <http://dx.doi.org/10.1109/APPEEC.2012.6307198>
- Mai, X. H., Kwak, S.K., Jung, J.H. and Kim, A.K. (2017). Comprehensive Electric-Thermal Photovoltaic Modeling for Power-Hardware-in-the-Loop Simulation (PHLS) Applications. *IEEE Transactions on Industrial Electronics*, 64(8), 6255-6264. <http://dx.doi.org/10.1109/TIE.2017.2682039>
- Meng, M., Yuan, Y., Guo, M., Jiang, L., Li, J., Hu, D., Cong, H., and Hao, D. (2014). A Novel DC Microgrid Based on Photovoltaic and Traction Power Supply System. 2014 IEEE Conference and Expo Transportation Electrification Asia-Pacific (ITEC Asia-Pacific) 1-4. <http://dx.doi.org/10.1109/ITEC-AP.2014.6941272>
- Mizuki, K., Yajima, H., Mineta, S., Sugita, S., Yamashita, N. and Babasaki, T. (2014). Maximizing Power-Supply Time of DC Power System with Photovoltaics and Fuel Cells. 2014 IEEE 35th International Telecommunications Energy Conference (IATELEC) 1-4. <http://dx.doi.org/10.1109/INTLEC.2014.6972121>
- Namenah, H., Tanougast, C., Cicero, L. (2014). Toward a prediction of the photovoltaic based power production from Experimental Thermal modeling. IEEE Conference and Expo Transportation Electrification Asia-Pacific (ITEC Asia-Pacific) 1-4. <http://dx.doi.org/10.1109/ITEC-AP.2014.6941218>
- Teuji, T., Hidaka, A. and Matsumoto, S. (2014). A Stand-Alone Power Supply System Using Single Photovoltaic Cell with Maximum Power Point Tracking. 2012 International Conference on Renewable Energy Research Applications (ICRERA) 1-5. <http://dx.doi.org/10.1109/ICRERA.2012.6477292>
- Wahid, A. and Hambali, W. A. (2015). Multi-Loop Control Design in Multivariable (2x2) Continuous Stirred Tank Reactor. *SINERGI* 1(2), 67-78. <http://dx.doi.org/10.72441/sinergi.2015.2.001>

Sinergi Yeni

ORIGINALITY REPORT

19%

SIMILARITY INDEX

13%

INTERNET SOURCES

13%

PUBLICATIONS

11%

STUDENT PAPERS

PRIMARY SOURCES

1	Submitted to Universiti Malaysia Pahang Student Paper	2%
2	Submitted to Asian Institute of Technology Student Paper	1%
3	Rachid Darbali-Zamora, Eduardo I. Ortiz-Rivera. "Optimal duty ratio maximum power point tracking technique using the SEPIC topology for photovoltaic systems applications", 2016 IEEE ANDESCON, 2016 Publication	1%
4	Submitted to University of Sheffield Student Paper	1%
5	Submitted to Universiti Teknologi MARA Student Paper	1%
6	polen.itu.edu.tr Internet Source	1%
7	Louise Stroyov, Sophiya Patel, Rafiq Ali. "Innovative fuel cell deployment in telstra's network and key learnings from the field", 2017	1%

IEEE International Telecommunications Energy Conference (INTELEC), 2017

Publication

8	zenodo.org Internet Source	1%
9	www.mdpi.com Internet Source	1%
10	www.tut.fi Internet Source	1%
11	T.I. Maris, St. Kourtesi, L. Ekonomou, G.P. Fotis. "Modeling of a single-phase photovoltaic inverter", Solar Energy Materials and Solar Cells, 2007 Publication	1%
12	hal.univ-reunion.fr Internet Source	1%
13	Ming Meng, Yaning Yuan, Mingwei Guo, Li Jiang, Jian Liu, Dalong Hu, Haiyang Cong, Dan Hao. "A novel DC microgrid based on photovoltaic and traction power supply system", 2014 IEEE Conference and Expo Transportation Electrification Asia-Pacific (ITEC Asia-Pacific), 2014 Publication	1%
14	Submitted to University of Birmingham Student Paper	1%

15	Submitted to CSU, San Jose State University Student Paper	1%
16	pure.tudelft.nl Internet Source	1%
17	Submitted to University of New South Wales Student Paper	1%
18	Meijun Lin, Zhenshu Wang, Yang Liu, Meng Chen, Fanyao Meng. "Power Prediction Model of Grid-Connected Photovoltaic and Power Flow Analysis", 2012 Asia-Pacific Power and Energy Engineering Conference, 2012 Publication	1%
19	Green Energy and Technology, 2015. Publication	<1%
20	Submitted to School of Business and Management ITB Student Paper	<1%
21	www.itec2014.com Internet Source	<1%
22	ktisis.cut.ac.cy Internet Source	<1%
23	Ali Farzan Moghaddam, Alex Van den Bossche. "Multi-Winding Equalization Technique for Lithium Ion Batteries for Electrical Vehicles", 2018 7th International Conference on	<1%

Renewable Energy Research and Applications (ICRERA), 2018

Publication

24

www.scirp.org

Internet Source

<1%

25

files.chartindustries.com

Internet Source

<1%

26

Rachid Darbali-Zamora, Nicols Cobo-Yepes, John E. Salazar-Duque, Eduardo I. Ortiz-Rivera, Amilcar A. Rincon-Charris. "Buck Converter and SEPIC Based Electronic Power Supply Design with MPPT and Voltage Regulation for Small Satellite Applications", 2017 IEEE 44th Photovoltaic Specialist Conference (PVSC), 2017

Publication

<1%

27

Akos Baldauf. "A smart home demand-side management system considering solar photovoltaic generation", 2015 5th International Youth Conference on Energy (IYCE), 2015

Publication

<1%

Exclude quotes

Off

Exclude matches

Off

Exclude bibliography

Off